

Outdoor Cat Shelter Directions

Supplies

1. Storage Tub— 18 gal (1-2 cats) or 30 gal (2-3 cats) Desert Color is best
2. Insulation— 4x8 polystyrene 1 1/2” thick sheet of insulation, can be purchased at Home Depot or Lowes. Insulation should have silver backing.
3. A Marker
4. Utility Knife— with a blade long enough to cut through the insulation
5. Straight Edge— for marking cuts
6. Tape Measure
7. Duct Tape - For seams of insulation and doorway into shelter
8. Straw

Remember these shelters are to help the cats stay warm they need to be functional they do not need to be pretty.



Step One

Measure and mark the insulation (on the white side) with the measurements provided on the next page. You will need to cut 4 sides, a top and bottom from the insulation. You should be able to get Three complete shelters out of a 4x8 piece of insulation

18 Gallon

End— 14" top width by 12 1/2" bottom width by 10 3/8" H (2)

Side— 16" top width by 14 1/2" bottom width by 10 5/8" H (2)

Bottom— 17 1/4" width by 13 1/4" H

Top— 19 1/2" width by 15 3/4" H

30 Gallon

End— 16" top width 13 1/2" bottom width by 12" H

Side— 22 1/2" top width 21 1/4" bottom width by 12" H

Bottom— 24" wide by 15" High

Top— 26" wide by 17 1/2" high

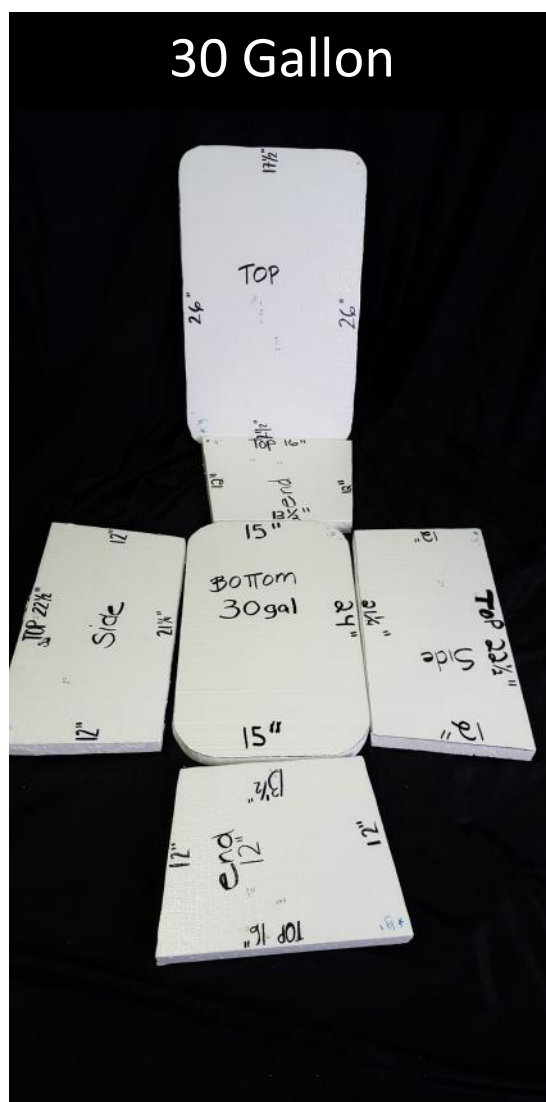
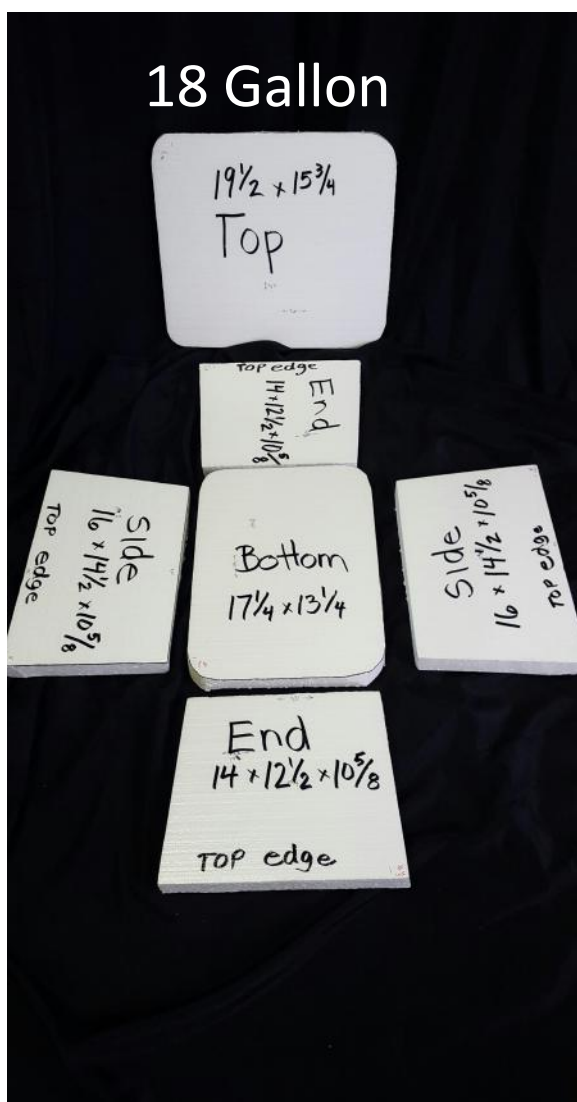

Step Two Cutting the Doorway

1. Measure 5 inches from the ground for the bottom edge of the door. Door is 5" wide at bottom and 5 3/4" high at center.
2. Cut the insulation for the door after it is fitted into the shelter.
3. When Cutting the door you will need to put the pint (tip) of the utility knife in first and push a whole into the plastic. You will not be able to "saw" the door, but push and cut into the plastic.



Step Three

1. Fit all the insulation into the tub (reflective silver side facing in) you may need to trim a little to make a better fit.
2. Trace the door opening on the front piece of insulation. Take the front piece of insulation out to cut the doorway.
3. Replace all insulation into the tub and begin taping all sides, and bottom together with the duct tape. This seals the insulation to help prevent air and cold from entering.
4. Take the correct length of tape, folding non sticky sides together then place into one corner of the insulation. Butterfly the top and bottom edge so the tape will lay flat.
5. Continue this on all sides and then move to the bottom

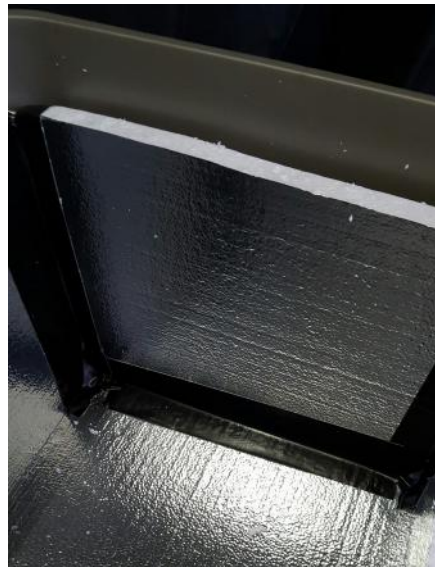
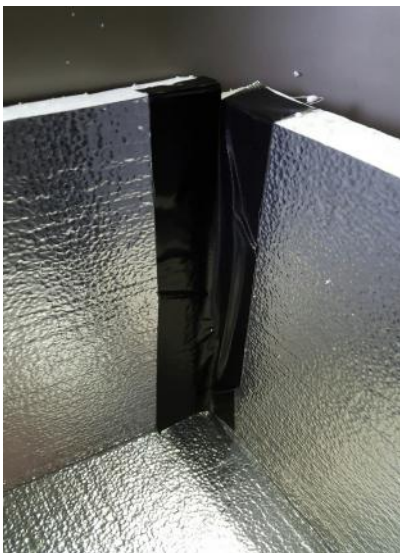

Step Four/Finish

1. Once the inside is taped up and secure remove the insulation so you can tape the outside seams. This will add an additional layer of protection and comfort.
2. It is ok if the pieces don't align perfectly, just tape and make sure to cover any gaps with the tape.
3. When you have finished taping the outside place the insulation back into the tub so you can tape up the doorway.
4. You will need to use many pieces of tape to cover the doorway completely.
5. Place the straw into any gaps between the tub and the insulation and into the bottom of the shelter. NEVER use towels in the bottom of the container towels absorb water and do not dry out, straw will prevent the space from getting wet and staying wet.
6. Place the insulation top onto the container, DO NOT tape it in place. This way it can be removed and the straw replaced. You have finished a cat shelter!



18 Gallon layout for 3 shelters on a 4x8 piece of insulation

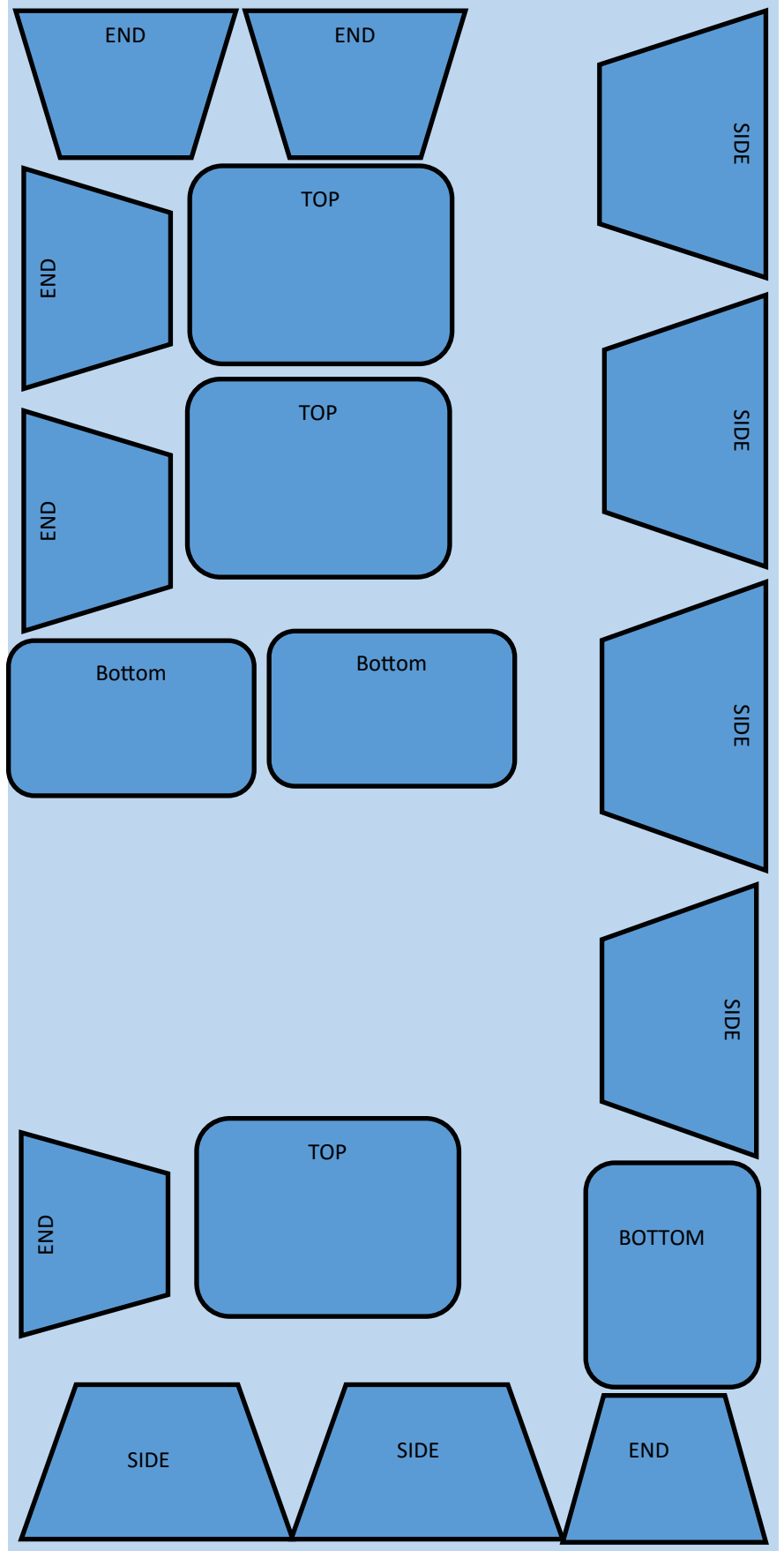
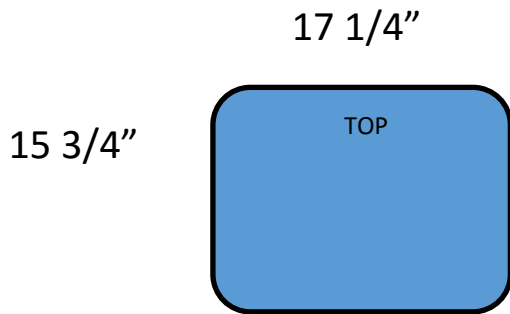
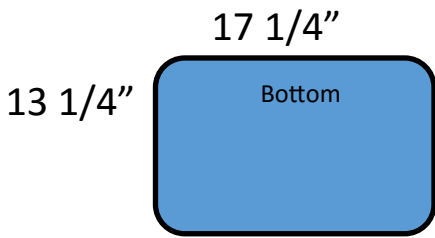
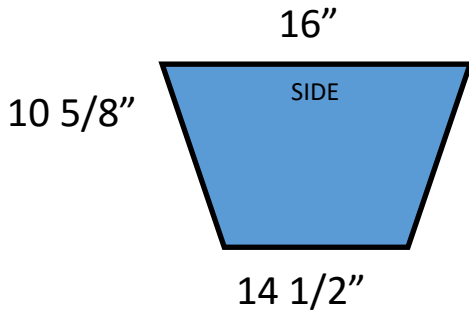
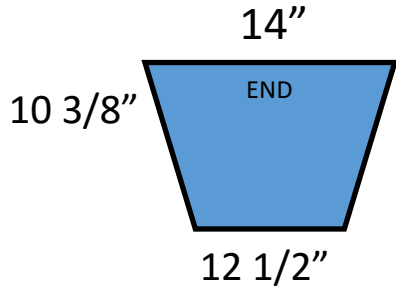

30 Gallon layout for 2shelters on a 4x8 piece of insulation

